



Hydra Super-S LCM

4-Bay RAID Storage Enclosure (3.5" SATA HDD)



User Manual

October 11, 2010 - v1.0



EN

CH

1 Introduction

1.1 System Requirements

1.1.1 PC Requirements

- Minimum Intel Pentium III CPU 500MHz, 128MB RAM
- eSATA equipped PC; Windows XP/Vista
- FireWire equipped PC; Windows XP/Vista
- USB 2.0 (USB 1.1) equipped PC; Windows XP/Vista
- Your hardware device must have the correct corresponding port (e.g. USB 2.0 host controller)
- Plug & Play support for eSATA host controller

1.1.2 Mac Requirements

- Minimum Apple G4 processor, 128MB RAM
- eSATA equipped Mac; Mac OS 10.4 or above
- FireWire equipped Mac; Mac OS 10.2 or above
- USB 2.0 (USB 1.1) equipped Mac; Mac OS 10.2 or above
- Your hardware device must have the correct corresponding port (e.g. USB 2.0 host controller)
- Plug & Play support for eSATA host controller

1.1.3 Supported Hard Drives

- Two to four 3.5" SATA-I or SATA-II hard drives (1.5Gb/s or 3.0Gb/s)
- Hard drives of identical capacities are recommended
- Supports large volumes in excess of 2TB

Note

In order for the computer to access volumes larger than 2TB, both the hardware and Operating System need to have the capacity to support large volumes (e.g.: Windows Vista or Mac OS 10.4 and above).

1.2 Package Contents

Package content may vary depending on vendor & version.

- Hydra Super-S LCM (hard drives not included)
- Power cord
- Interface cables
- User manual

1.3 About this Manual

Firmware, images and descriptions may slightly vary between this manual and the actual product you have. Functions and features may change depending on the firmware version. Please read your warranty carefully, as this may vary between different vendors!

1.4 Trademarks

- MS-DOS, Microsoft and Windows XP/Vista are trademarks of Microsoft Corporation.
- Apple Macintosh and Mac are trademarks of Apple Computer.
- All other third party brands and names are the property of their respective owners.

1.5 Detailed View

1.5.1 Front View

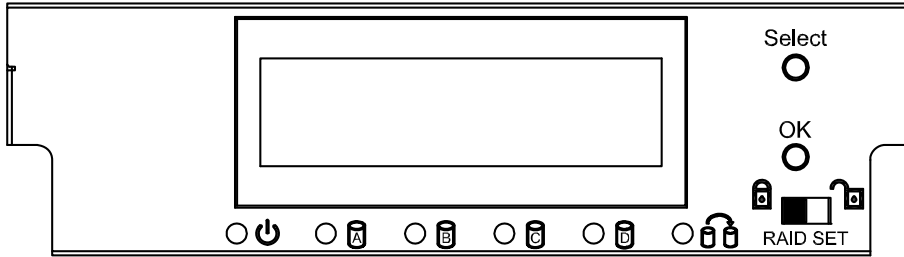

LED/Button	Status
	<ul style="list-style-type: none"> Blue = Power on
	<ul style="list-style-type: none"> Flashing green = Accessing data Flashing red = System starting up Steady red = Error or drive is not installed
	<ul style="list-style-type: none"> Flashing yellow = Rebuilding RAID array Steady yellow = One or more faulty drive(s)
	<ul style="list-style-type: none"> RAID mode can be changed via LCD display
	<ul style="list-style-type: none"> RAID mode locked
Select	<ul style="list-style-type: none"> Select setup menu or mode
OK	<ul style="list-style-type: none"> Confirm current option or enter setup menu



When only 2 or 3 hard drives are installed, the red LED indication for the missing hard drives can be safely ignored.



Changing the RAID mode requires you to re-format the drives. This will erase all data on the hard drives that are being formatted. Make sure to backup all existing data first!

Note

In order to prevent an accidental change of the RAID mode, it can be locked. When the RAID mode is locked, it is not possible to change or access the RAID settings via LCD display. Instead, the display will show a message saying "RAID Mode Locked".

1.5.2 Rear View

Label	Description
	Security lock slot
ON/OFF	Power switch
AC: 100~240V	Power receptacle
eSATA	External SATA port
FW400	FireWire 400 (1394a) port
FW800	FireWire 800 (1394b) port
USB 2.0	USB 2.0 High Speed port

1.6 RAID Mode

Hard drives of identical capacities are recommended. If the capacities are different, the total amount of the space that can be used will depend on the drive with the smallest capacity. The difference in performance is only visible for fast interfaces like eSATA.

Note

Changing the RAID mode requires you to re-format the drives. This will erase all data on the hard drives that are being formatted. Make sure to backup all existing data first!

1.6.1 Disk Spanning

The drives show up as one large single volume but the total size will depend on the drive with the smallest capacity. Spanning is an array (not RAID) that is written sequentially across the drives. By itself, it does not provide any performance or redundancy benefits.

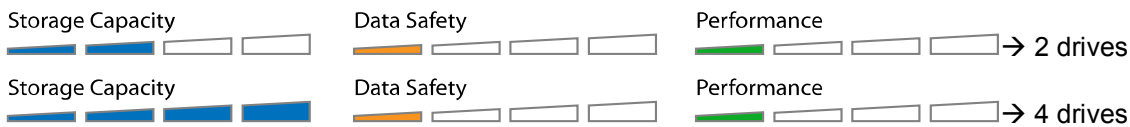

1.6.2 Disk Striping (RAID 0)

The drives show up as one large single volume but the total size will depend on the drive with the smallest capacity. Used where speed is the primary objective but RAID Level 0 (also called striping) is not redundant. This form of array splits each piece of data across the drives in segments. Since data is written without parity data-checking, it allows for the fastest data transfer but if one drive fails, the whole array can become corrupted.

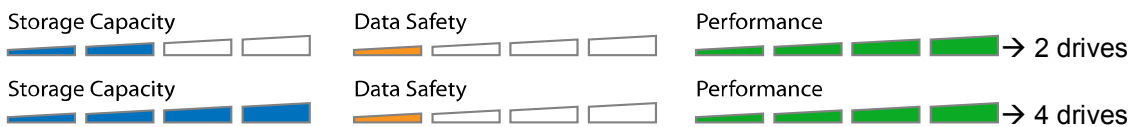

1.6.3 Disk Mirroring (RAID 1)

The drives show up as one volume but only 50% of the total capacity, depending on the drive with the smallest capacity, can be used. RAID 1 creates an exact copy (or mirror) of a set of data on the second drive. This is useful when reliability and backup are more important than capacity. When one drive fails, it can be replaced and the data rebuilt.



1.6.4 Disk Mirroring with Striping (RAID 10)

The drives show up as one volume but only 50% of the total capacity, depending on the drive with the smallest capacity, can be used. RAID 10 creates an exact copy (or mirror) of a set of data. This is useful when reliability and backup are more important than data capacity. When one hard drive fails, it can be replaced and the data rebuilt automatically.



1.6.5 Disk Striping with dedicated parity (RAID 3)

The drives show up as one volume but the total capacity, depending on the drive with the smallest capacity, is the combined size minus the size of one drive. RAID 3 uses byte-level striping with parity data stored on a dedicated disk. The single parity disk is a bottle-neck for writing since every write requires updating the parity data. One minor benefit is the dedicated parity disk allows the parity drive to fail and operation will continue without parity or performance penalty. When one hard drive fails, it can be replaced and the data rebuilt automatically.

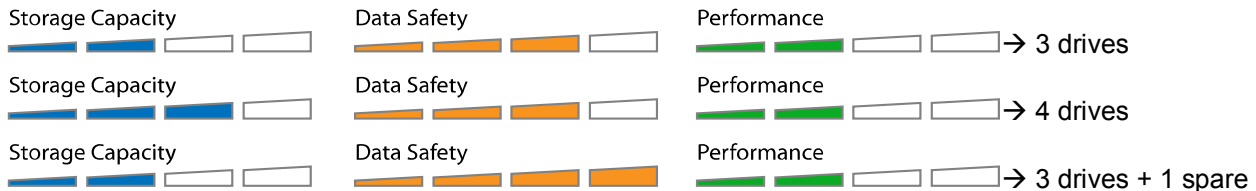

Spare Drive

When 3 hard drives plus 1 spare drive are used, the total capacity will only be as large as two drives. When one drive fails, the data will be rebuilt immediately by using the spare drive, rather than waiting for someone to replace the faulty one. To use a spare drive, install 3 drives, turn on the device, set it to RAID 3, let it restart and then install the fourth drive.

1.6.6 Disk Striping with distributed parity (RAID 5)

The drives show up as one volume but the total capacity, depending on the drive with the smallest capacity, is the combined size minus the size of one drive. RAID 5 uses block-level striping with parity data distributed across all member disks and therefore provides the perfect balance between high performance and data integrity. When one hard drive fails, it can be replaced and the data rebuilt automatically.

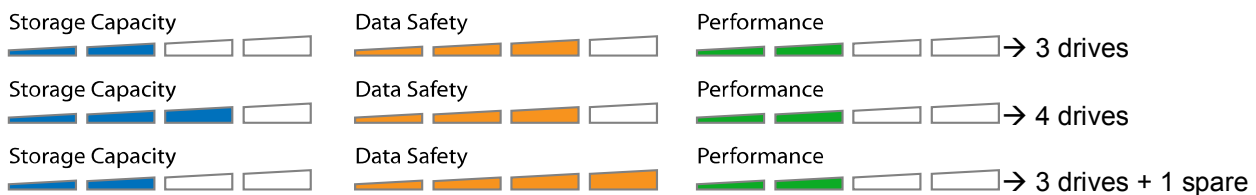

Spare Drive

When 3 hard drives plus 1 spare drive are used, the total capacity will only be as large as two drives. When one drive fails, the data will be rebuilt immediately by using the spare drive, rather than waiting for someone to replace the faulty one. To use a spare drive, install 3 drives, turn on the device, set it to RAID 5, let it restart and then install the fourth drive.

Note

It is not possible to add more drives to an existing RAID array without re-formatting it. To add additional drives at a later point, install the drive(s), change the RAID mode or re-confirm the current mode and then create a new partition and format the drives again.

1.7 About Data Backup

To protect your files and help prevent the loss of your data, we strongly recommend that you keep two copies of your data, one copy on your Hydra and a second copy either on your internal drive or another storage media such as CD, DVD, Tape or an additional external drive.

Any loss or corruption of data while using the Hydra is the sole responsibility of the user, and under no circumstances will the manufacturer be held liable for compensation or the recovery of this data.

2 System Setup

2.1 Hard Drive Assembly

The drives can be installed at any position, there is no specific order required. Be careful not to damage any components, and do not force the drives into place. If they don't slide in properly, make sure the drives have been installed correctly.

1. Unlock the switch at the bottom of the case, push the inner chassis from the back until the front panel is out of the housing, pull the front panel out and then lift it up to remove it. Turn the screws on the cassettes counter-clockwise to loosen and pull them out.

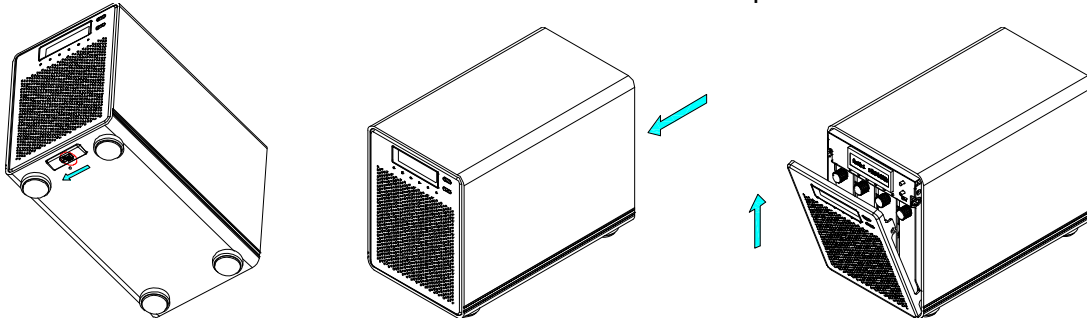

2. Install the hard drive as illustrated below with the SATA connector facing away from the front. Mount the drive with the six screws from the side.

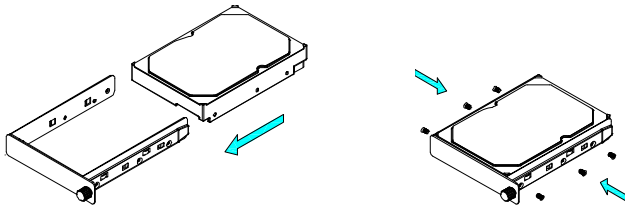

3. Slide the cassette back into the case, push it lightly into place and fasten the screw.
4. Repeat the previous steps for each hard drive cassette you are planning to install.
5. Replace the front panel, turn on the power, connect the drive to your computer, set your preferred RAID mode, create a new partition and format the drives.

Note

It is not possible to add more drives to an existing RAID array without re-formatting it. To add additional drives at a later point, install the drive(s), change the RAID mode or re-confirm the current mode and then create a new partition and format the drives again.

Important

Upon initial start up of the device and when changing the RAID mode, any existing data on the installed hard drives will be erased. Please make sure you backup all data prior to installing the hard drives and prior to changing the RAID mode!

2.2 Replacing Hard Drives

When one of the drives fails, the Rebuild LED will light up yellow and the corresponding HDD LED will light up red. If only one drive is defective and the RAID mode is set to RAID 1, RAID 3, RAID 5 or RAID 10, the data can still be accessed but we strongly recommend replacing the faulty drive immediately to assure continued backup and data safety.

If more than one drive at the same time fails or if the RAID mode is set to RAID 0 or Spanning, the data will be lost and the system can not be accessed again until the drive(s) have been replaced.

1. Check the HDD LED and replace the faulty drive. The red LED indicates the defective HDD. The power does not have to be turned off when replacing the drive(s).
2. A few seconds after installing the new drive(s) the corresponding LED will turn green.
3. For RAID 1, RAID 3, RAID 5 and RAID 10, the RAID array will be rebuilt automatically. During this process, the Rebuild LED will be flashing yellow. Rebuilding the RAID array will take several hours, depending on the drive capacity.
4. For RAID 0 and Spanning, erase the old partition, create a new one and then format the drives again.

Note

We recommend not turning off the power during the rebuild process but if it is interrupted, it will continue rebuilding the data as soon as the power is turned back on.

2.3 Connection to Computer

A few precautions and notes when using your external storage drive:

- Do not expose the product to water or humid conditions.
- Do not cover the enclosure's ventilation holes.
- Only one interface can be used at any given time.
- When more than one cable is connected, the eSATA connection has priority. To use a different interface, disconnect the other cables first, before connecting the new one.
- Before connecting the device, install the hard drives and set your preferred RAID mode.
- For the safe removal of your drive and to assure that no data is lost, always follow the correct unplug procedure for external hardware (e.g.: Eject the drive before removal).
- In order for the computer to access volumes larger than 2TB, both the hardware and Operating System need to support large volumes (e.g.: WinVista 32bit/64bit or Mac OS 10.4 and above) or the >2TB option should be disabled

3 LCD Display

The LCD display shows the system status, detailed information about the hard drives as well as the system configuration and provides the option to modify certain device settings.

To select a menu or change an option, use the [Select] button. To enter a menu and confirm a change, use the [OK] button. For further details, follow the on-screen wizard or refer to the following step by step descriptions.

3.1 Main Menu

Press the [Select] button to change between the different menus and press the [OK] button to enter a menu.

1. The main screen displays the product name and the current RAID mode.
2. The system information will show further details about the device configuration and the hardware.
3. The HDD information will show further details about the installed hard drives.
4. The settings menu offers options to change the device configuration.

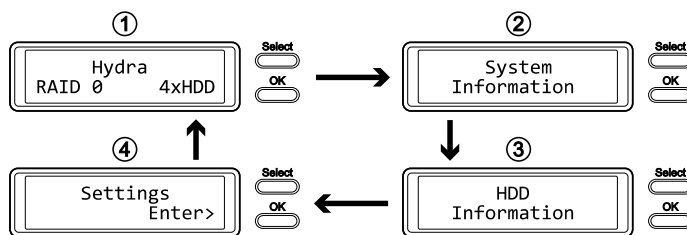

3.2 System Information

Press the [Select] button until the system information menu is selected and then press the [OK] button to start displaying further details about the device configuration and the hardware. It will automatically cycle through the different information displaying each screen for about 8 seconds and then return to the main screen. To fast forward, press the [Select] button.

1. The main screen of the system information menu.
2. The serial number is a combination of the 1394 vendor ID, the chip ID Hi and the chip ID Lo.
3. Displays the current firmware version of the Hydra Super-S LCM.
4. The I/O status shows the interface that is currently used for the connection to the computer.
5. Displays the current speed of the smart-fan and the temperature from its thermal probe.
6. Displays the current status of the >2TB and the alarm function.
7. Displays how the RAID mode is set (LCM = LCD display, AP = external program) and the total storage capacity.

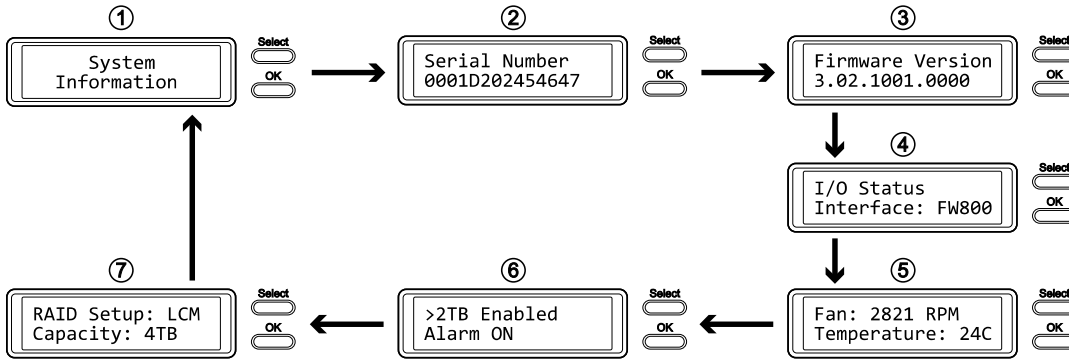

3.3 HDD Information

Press the [Select] button until the HDD information menu is selected and then press the [OK] button to start displaying further details about the installed hard drives. It will automatically cycle through the different information displaying each screen for about 8 seconds and then return to the main screen. To fast forward, press the [Select] button.

1. The main screen of the HDD information menu.
2. Displays the model number and serial number of the drive installed at HDD1.
3. Displays the total storage capacity and the temperature of the drive installed at HDD1.
4. The same information is also displayed for the drives installed at HDD2, HDD3 and HDD4.

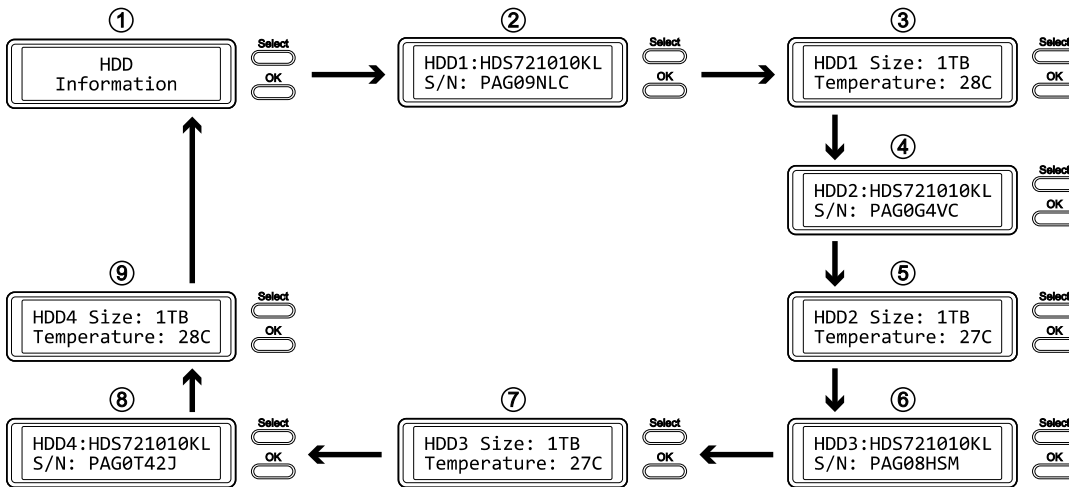

3.4 Settings

Press the [Select] button until the settings menu is selected and then press the [OK] button to enter the configuration menu. You can now use the [Select] button to cycle through the different settings and the [OK] button to further configure the device settings.

1. Option to enable or disable the support for large volumes in excess of 2TB.
2. Setup menu for the RAID settings.
3. Option to enable or disable the general alarm sound.
4. Option to enable or disable the temperature alarm sound.
5. Setup menu to define the fan speed of the smart fan.
6. Setup menu to define how long the backlight for the LCD display stays lit.
7. To exit the settings menu and return to the main menu.

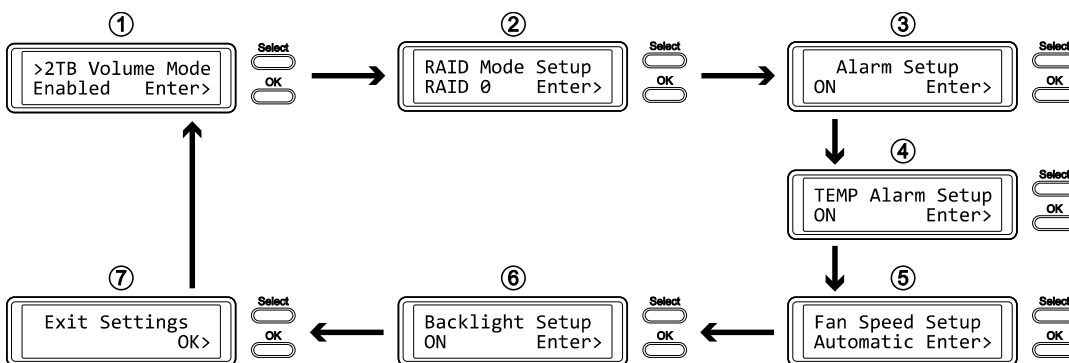

3.4.1 >2TB Volume Mode

In order for the computer to access volumes larger than 2TB, both the hardware and Operating System need to have the capacity to support large volumes (e.g.: WinVista 32bit/64bit or Mac OS 10.4 and above) or the >2TB option should be disabled.

- [Enabled] Supports volumes in excess of 2TB. If the total storage capacity exceeds 2TB, older Operating Systems will not be able to mount and access the drive.
- [Disabled] Only supports volumes up to 2TB. If the total storage capacity exceeds 2TB, the remaining storage space can not be accessed but on the other hand, older Operating Systems are still able to use the drive.

Press the [OK] button to enter the setup menu and press the [Select] button to cycle through the different options.

- To exit the menu without changing any of the settings, press the [Select] button until you see the Exit screen and then press the [OK] button.
- To change the setting, press the [Select] button to choose your preferred mode, press the [OK] button to select it and then press the [OK] button again to confirm the change.

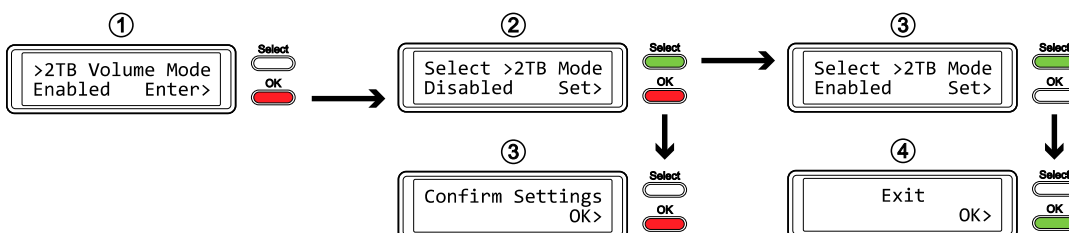

3.4.2 RAID Mode Setup

In order to set the RAID mode via LCD display, make sure the RAID SET switch behind the front panel is not in the locked position.

- [SPAN] Disk spanning.
- [RAID 0] Disk striping.
- [RAID 1/10] Disk mirroring (2xHDD → RAID 1, 4xHDD RAID 10).
- [RAID 3] Disk striping with dedicated parity. To use a spare drive, install 3 drives, turn on the device, set it to RAID 3, let it restart and then install the fourth drive.
- [RAID 5] Disk striping with distributed parity. To use a spare drive, install 3 drives, turn on the device, set it to RAID 5, let it restart and then install the fourth drive.

Press the [OK] button to enter the setup menu and press the [Select] button to cycle through the different options.

- To exit the menu without changing any of the settings, press the [Select] button until you see the Exit screen and then press the [OK] button.
- To change the setting, press the [Select] button to choose your preferred mode, press the [OK] button to select it, press the [OK] button again to confirm the change and once more to acknowledge that all data will be erased by this change. The device will restart automatically and after start up, one more confirmation is required to set the new RAID mode.

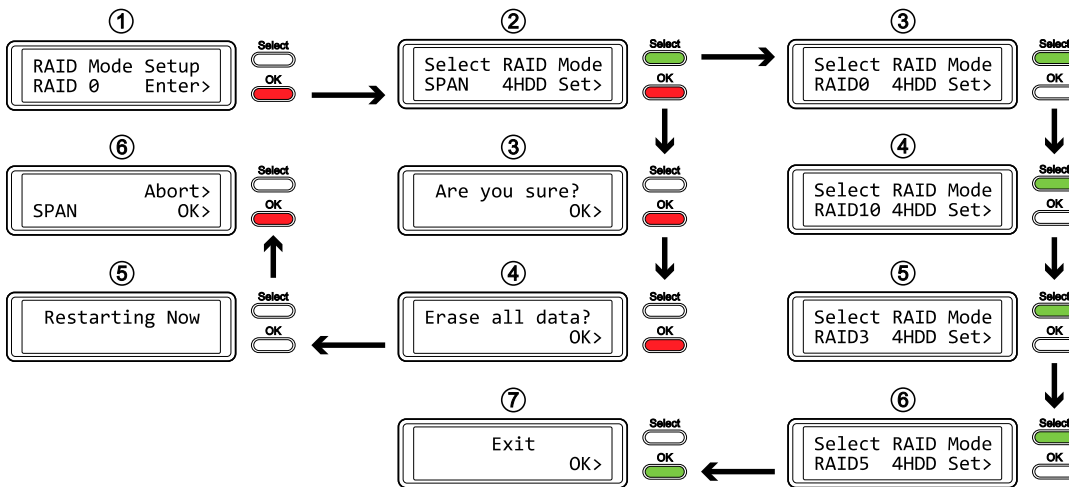

Note

Changing the RAID mode requires you to re-format the drives. This will erase all data on the hard drives that are being formatted. Make sure to backup all existing data first!

The amount of hard drives that are currently installed will be displayed right after the RAID mode (e.g. 4HDD). This information is for reference only and can not be selected or changed via LCD display, so the RAID array will be built with the current amount of drives.

3.4.3 Alarm Setup

The general alarm sound is the short beep you hear when starting up the system and it will sound when something is wrong. To enable or disable the alarm, do one of the following.

- [ON] Beeper and alarm is enabled.
- [OFF] Beeper and alarm is disabled.

Press the [OK] button to enter the setup menu and press the [Select] button to cycle through the different options.

- To exit the menu without changing any of the settings, press the [Select] button until you see the Exit screen and then press the [OK] button.
- To change the setting, press the [Select] button to choose your preferred mode and then press the [OK] button to confirm the change.

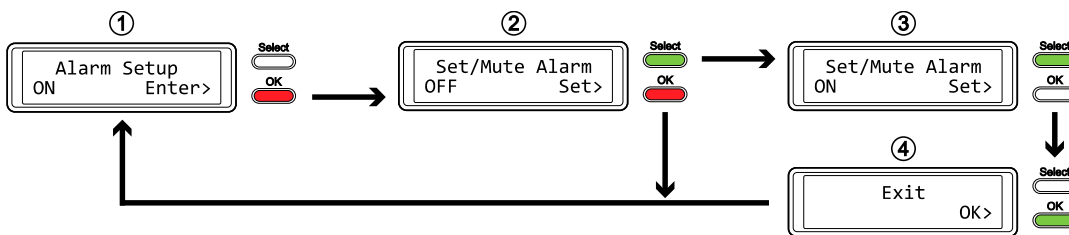

3.4.4 TEMP Alarm Setup

This is the alarm sound you hear when the internal temperature that is measured by the thermal probe reaches a critical level (>61°C). You can enable or disable it here.

- [ON] High temperature alarm is enabled.
- [OFF] High temperature alarm is disabled.

Press the [OK] button to enter the setup menu and press the [Select] button to cycle through the different options.

- To exit the menu without changing any of the settings, press the [Select] button until you see the Exit screen and then press the [OK] button.
- To change the setting, press the [Select] button to choose your preferred mode and then press the [OK] button to confirm the change.

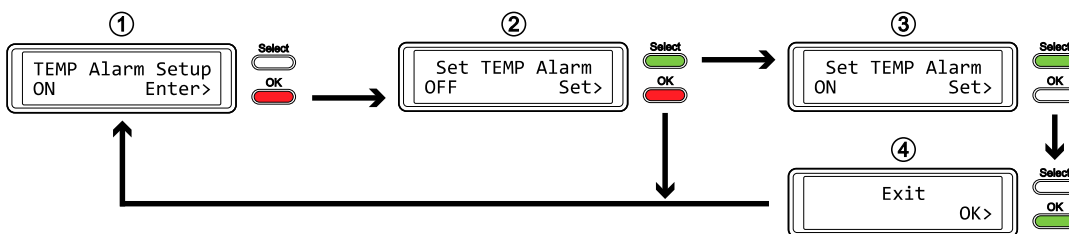

3.4.5 Fan Speed Setup

The smart-fan can automatically regulate the fan speed according to the internal case temperature, it can be set at a certain speed or it can be deactivated.

- [Automatic] Regulates the fan speed according to the HDD temperature (below 45°C = low speed, 45-60°C = speed increases in 5 steps, above 61°C = high speed).
- [HighSpeed] Fan speed is set to high speed.
- [LowSpeed] Fan speed is set to low speed.
- [OFF] The fan is turned off. This setting should only be used if the device is located in a cool and temperature controlled room.

Press the [OK] button to enter the setup menu and press the [Select] button to cycle through the different options.

- To exit the menu without changing any of the settings, press the [Select] button until you see the Exit screen and then press the [OK] button.
- To change the setting, press the [Select] button to choose your preferred mode and then press the [OK] button to confirm the change.

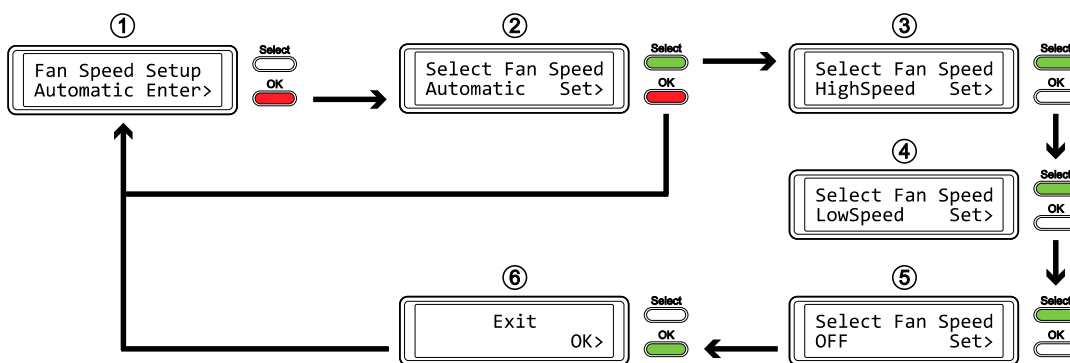

3.4.6 Backlight Setup

The backlight for the LCD display can be enabled, disabled or set so that it turns off automatically, when the screen has been idle for a certain amount of time.

- [ON] Always ON.
- [OFF] Always OFF.
- [1min] Backlight turns off when the screen has been idle for more than one minute.
- [3min] Backlight turns off when the screen has been idle for more than three minutes.
- [5min] Backlight turns off when the screen has been idle for more than five minutes.

Press the [OK] button to enter the setup menu and press the [Select] button to cycle through the different options.

- To exit the menu without changing any of the settings, press the [Select] button until you see the Exit screen and then press the [OK] button.
- To change the setting, press the [Select] button to choose your preferred mode and then press the [OK] button to confirm the change.

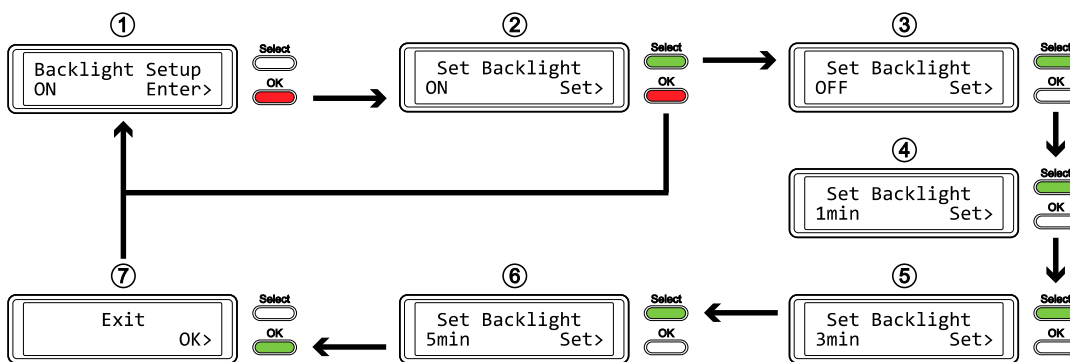

3.5 Event Information

In addition to the details about the hardware and device configuration, the LCD display will also show certain event information. Following is a list of possible messages and their meanings.

- **[HDD Error / Remaining 3xHDD]**
When using RAID 0 or SPAN and one of the drives fails, the alarm will go off and the display indicates the amount of the remaining drives that are still working OK. Refer to the HDD LED's in order to locate the defective drive.
- **[RAID Warning / Degraded Array]**
When using RAID 1, 10, 3 or 5 and one of the drives fails, the alarm will go off and the display shows this message. Press the [OK] button to temporarily mute the alarm and use the HDD LED's in order to locate the defective drive.
- **[XX Cable / Connected]**
Shows which cable has been connected.
- **[Cable / Disconnected]**
Shows when the cable has been unplugged.
- **[Rebuilding... / Hrs left xhxxmin]**
Shows during the rebuild process of a RAID array with an approximate time in hours and minutes indicating how long it takes until the backup is done.
- **[Alarm / High Temperature]**
Indicates critical temperature (>61°C).
- **[Alarm / Fan Failure]**
Indicates a fan failure or unexpectedly slow RPM.
- **[Detecting Disk / Starting...]**
Shows during start up of the system.
- **[XX / Starting ...]**
Shows during start up of the system.
- **[RAID Mode Locked]**
Shows when trying to change the RAID mode via LCD display but the RAID SET switch is set to lock the settings.

4 Appendix

4.1 Safety Information

4.1.1 6-pin FireWire cable

When using a 6-pin FireWire cable, make sure NOT to insert the connector the wrong way (upside down), or you will damage the device!

4.1.2 Location and placing precautions

Do not cover the device and do not place the unit on other heat-sensitive equipment. Avoid positioning it in the following places:

- Locations with direct sunlight, next to radiators or other sources of heat with high temperatures (more than 35° C) or high humidity (more than 90%).
- Locations subject to vibration, shock, or with a slope.
- Do not expose the product to water or humid conditions.

4.1.3 Electricity and power plug

Careful attention must be paid to the following points in order to avoid electric shock or fire:

- Always connect the power cord to your device before you plug it into the wall socket.
- Do not touch the power cable with wet hands and never try to modify the power cable.
- If the unit should emit smoke, an unusual odour or noise, switch it off immediately.
- Use only the cables supplied or recommended by your vendor in order to avoid malfunction.

4.2 FAQ

Q: What file system should I choose to format my drive?

A: This will depend on how you want to use the drive but in general, we recommend:

- Windows XP/Vista → NTFS
- Mac OS X → HFS+ (Mac OS Extended)
- To use it on both PC and Mac → FAT32 (single files size is limited to 4GB)

Q: How many drives can fail before I loose my data?

A: This depends on the RAID mode. For RAID 0 and Spanning, any drive failure will result in the data being lost. For RAID 1, RAID 3, RAID 5 and RAID 10, more than one drive failure at the same time will mean the data can not be recovered anymore.

Q: Will the hard drives spin down when my computer goes into stand-by mode?

A: No, to provide immediate access to your data, the drives will always keep spinning as long as the power is turned on.

Q: Why does the LED indication for some of the drives light up red?

A: If one of the HDD LEDs lights up red and at the same time the Rebuild LED lights up yellow, the drive is defective. If less than 4 drives are installed and the Rebuild LED does not light up at the same time, it simply indicates that there is no drive in that bay.

© Copyright 2010 by AKiTiO. All Rights Reserved

The information contained in this manual is believed to be accurate and reliable. AKiTiO assumes no responsibility for any errors contained in this manual. AKiTiO reserves the right to make changes in the specifications and/or design of this product without prior notice. The diagrams contained in this manual may also not fully represent the product that you are using and are there for illustration purposes only. AKiTiO assumes no responsibility for any differences between the product mentioned in this manual and the product you may have.



Hydra Super-S LCM

四插槽 RAID 陣列儲存外接盒 (3.5 吋 SATA 硬碟)



使用者說明書

2010 年 10 月 11 號 - v1.0



EN

CH

1 產品簡介

1.1 系統需求

1.1.1 PC需求

- Intel Pentium III CPU 500MHz, 128MB RAM 以上
- 有支援 eSATA 的系統 (Windows XP/Vista/7)
- 有支援 FireWire 的系統 (Windows XP/Vista/7)
- 有支援 USB 2.0 (USB 1.1) 的系統 (Windows XP/Vista/7)
- 您的電腦必須要有對應的連接埠
- eSATA 的隨插即用支援

1.1.2 Mac系統需求

- Apple G4 處理器, 128MB RAM 以上
- 有支援 eSATA 的系統 (Mac OS 10.4 以上)
- 有支援 FireWire 的系統 (Mac OS 10.2 以上)
- 有支援 USB 2.0 (USB 1.1) 的系統 (Mac OS 10.2 以上)
- 您的電腦必須要有對應的連接埠
- eSATA 的隨插即用支援

1.1.3 支援的硬碟類型

- 二到四個 3.5" SATA-I 或 SATA-II 硬碟 (傳輸速度 1.5Gb/s 或 3.0Gb/s)
- 建議使用相同容量的硬碟
- 支援容量超過 2TB 的硬碟

注意

為了使電腦可以存取容量為 2TB 以上的硬碟磁區，您必須使用有支援大容量硬碟的作業系統 (例如 Windows Vista/7 或 Mac OS 10.4 以上)

1.2 包裝內容

包裝內容可能會隨著版本和商家而有所不同

- Hydra Super-S LCM 外接盒 (不含硬碟)
- 電源供應器
- 資料傳輸線
- 使用者說明書

1.3 關於本說明書

韌體版本、圖片以及說明敘述可能會與您所拿到的產品有所不同。不同的韌體版本可能會造成功能和介面上的差異。請仔細閱讀保固說明，保固說明可能會依商家而有所不同。

1.4 商標

- MS-DOS, Microsoft, Windows XP/Vista/7 是 Microsoft Corporation 的商標。
- Apple Macintosh 以及 Mac 是 Apple Computer 的商標。
- 所有第三方產品的商標和名稱是由它們的擁有者所有。

1.5 產品外觀

1.5.1 前方外觀

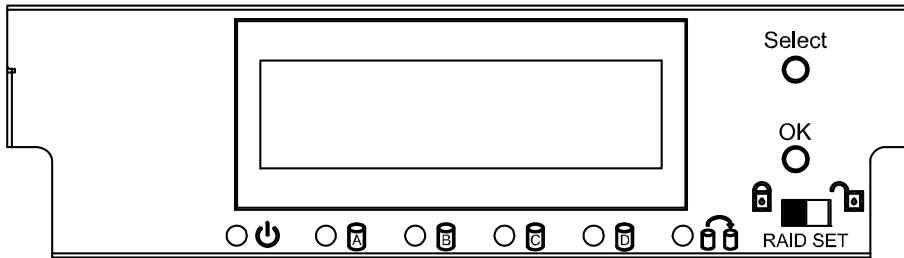

LED/按鈕	狀態顯示
	<ul style="list-style-type: none"> 藍燈 = 電源開啟
	<ul style="list-style-type: none"> 閃爍綠燈 = 資料存取中 閃爍紅燈 = 系統啟動中 持續紅燈 = 硬碟未放入或者硬碟錯誤
	<ul style="list-style-type: none"> 閃爍黃燈 = 重建 RAID 陣列中 持續黃燈 = 一個或多個硬碟損毀
	<ul style="list-style-type: none"> RAID 模式可以從 LCD 面板的設定中修改
	<ul style="list-style-type: none"> RAID 模式已經被鎖定
Select	<ul style="list-style-type: none"> 選擇設定選單或模式
OK	<ul style="list-style-type: none"> 確定目前選項，或者進入設定選單



當您只安裝二或三個硬碟時，您可以忽略紅色指示燈所顯示的未安裝硬碟之錯誤。



改變 RAID 模式需要重新格式化您的硬碟，這個動作會刪除硬碟中的所有資料，請確認您已事先備份所有的資料！

注意

您可以鎖定以防止不小心改變 RAID 模式，當 RAID 模式被鎖定時，您不能從 LCD 面板的設定中修改 RAID 設定，此時系統會顯示「RAID Mode Locked」。

1.5.2 後方外觀

Label	說明
	防盜鎖孔
ON/OFF	電源開關
AC: 100~240V	電源插座
eSATA	External SATA 連接埠
FW400	FireWire 400 (1394a) 連接埠
FW800	FireWire 800 (1394b) 連接埠
USB 2.0	USB 2.0 連接埠

1.6 RAID模式

我們建議您使用相同容量的硬碟，若您使用不同容量的硬碟，則總容量將視容量最小的硬碟而定。在各個 RAID 模式之間的傳輸速度差異，只有在當您使用較快的傳輸介面（如：eSATA）時會比較明顯。

注意

改變 RAID 模式需要重新格式化您的硬碟，這個動作會刪除硬碟中的所有資料，請確認您已事先備份所有的資料！

1.6.1 磁碟延展

您的硬碟容量將會顯示為單一空間，其容量大小將視您容量最小的硬碟而定。磁碟延展模式是一種跨硬碟讀寫的磁碟陣列（但並非 RAID），且不能提供任何的速度提昇或資料安全備份。

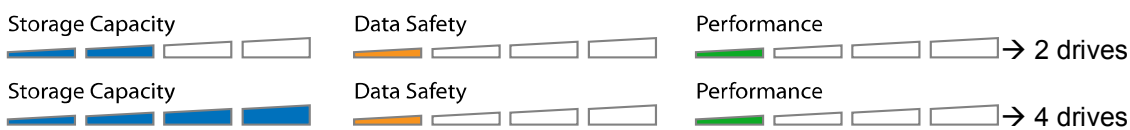

1.6.2 RAID 0 – 磁碟分段

您的硬碟容量將會顯示為單一空間，其容量大小將視您容量最小的硬碟而定。此模式適合在您的主要需求為速度時使用，此種陣列型態會將資料分割成數個部份，並分別儲存在不同硬碟中，因此能達到最高的檔案傳輸速度，但因為資料並未有任何備份，因此若其中一個硬碟故障，將可能導致所有資料損毀。

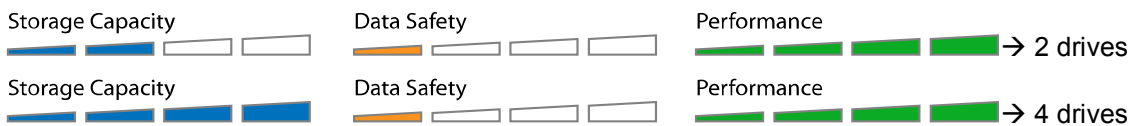

1.6.3 RAID 1 – 磁碟鏡像

硬碟空間將顯示為所有硬碟總容量一半的單一空間，其大小將視您容量最小的硬碟而定。RAID 1 將複製資料到第二個硬碟，當資料的安全性及備份較容量重要時這是相當實用的功能，當一個硬碟故障時，您可以更換硬碟，使得資料重建，而不致於遺失您的資料。



1.6.4 RAID 10 – 磁碟鏡像與磁碟分段



硬碟空間將顯示為總容量一半的單一空間，其大小將視您容量最小的硬碟而定。RAID 1 將複製資料到第二個硬碟，當資料的安全性及備份較容量重要時，這是相當實用的功能。當一個硬碟故障時，您可以更換硬碟，且系統會自動重建資料。

1.6.5 磁碟分段並使用專屬同位元檢查硬碟 (RAID 3)

硬碟將顯示為單一空間，其大小將視您容量最小的硬碟而定。該硬碟大小將會是所有硬碟容量的總和，再減掉一個硬碟的容量。**RAID 3** 使用位元分段的方式，在一個專屬硬碟中寫入容錯資訊。然而由於每次寫入資料時，都必須在專屬硬碟再寫入一份容錯資訊，因此該硬碟會變成在寫入速度方面的瓶頸。此種陣列的好處是，當一個硬碟損毀時，由於有專屬硬碟來處理容錯資訊，因此您的資料可以繼續正常存取，而不會有任何的資料損毀或存取速度上的差異。當一個硬碟故障時，您可以更換硬碟，且系統會自動重建資料。

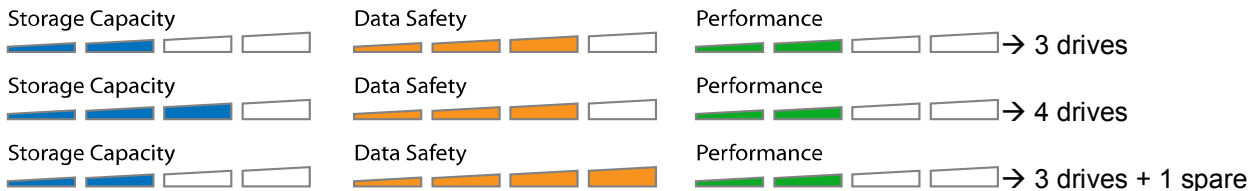

備用磁碟

當您使用三個硬碟，加上一個備用硬碟時，磁碟空間將會顯示為兩個硬碟的容量總和。若一個硬碟損毀時，資料將會藉由備用硬碟馬上重建，而不需要先行更換新的硬碟。若要使用備用硬碟的話，請先安裝三個硬碟到裝置中，之後開啟裝置，設定為 **RAID 3**，等到系統重新啟動之後，再安裝第四個硬碟。

1.6.6 磁碟分段並使用分散式同位元檢查 (RAID 5)

硬碟將顯示為單一空間，其大小將視您容量最小的硬碟而定。該硬碟大小將會是所有硬碟容量的總和，再減掉一個硬碟的容量。**RAID 5** 使用區塊分段的方式，將容錯資訊分散在各個硬碟當中。因此，這樣的陣列方式，既可以提供快速的存取速度，也可以保持資料的完整性。當一個硬碟故障時，您可以更換硬碟，且系統會自動重建資料。

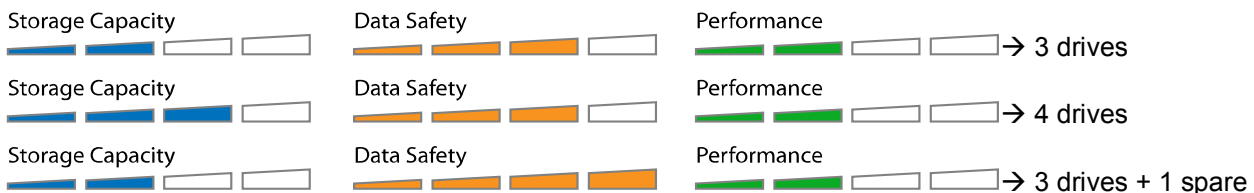

備用硬碟

當您使用三個硬碟，加上一個備用硬碟時，磁碟空間將會顯示為兩個硬碟的容量總和。若一個硬碟損毀時，資料將會藉由備用硬碟馬上重建，而不需要先行更換新的硬碟。若要使用備用硬碟的話，請先安裝三個硬碟到裝置中，之後開啟裝置，設定為 **RAID 5**，等到系統重新啟動之後，再安裝第四個硬碟。

注意

您不能在不重新格式化硬碟的情形下，將新的硬碟加入到現有的磁碟陣列當中。若要新增硬碟的話，您必須先安裝硬碟，之後改變 **RAID** 模式或者重新格式化硬碟，接著再新增一個新的磁區，並再次格式化該磁區。

1.7 關於資料備份

為了保護您的資料並避免資料遺失，我們強烈建議您準備兩份的資料備份，一份在本裝置中，另外一份則可以在您的內接硬碟、CD、DVD、磁帶，或者其他外接裝置中。

任何在使用本裝置的時候所造成的資料遺失或損毀，其責任藉由使用者負擔，且在任何情況下製造商皆不需賠償，或者還原資料。

2 系統設定

2.1 硬碟安裝

硬碟可以以水平或垂直的方向安裝，而無任何的要求。安裝硬碟時，請特別小心，別損毀任何的產品配件，並且請勿強制將硬碟塞入裝置中。若硬碟並不能順利的放入裝置中時，請確認您用正確的方式來安裝硬碟。

1. 將外接盒底部的切換開關解除鎖定，從後面推動裝置內部的底盤，直到前方面板與裝置分離為止。接著將前方面板往上拉，以將之從裝置上拆下。之後將硬碟固定架外的固定螺絲以逆時針方向旋轉，再將固定架拉出。

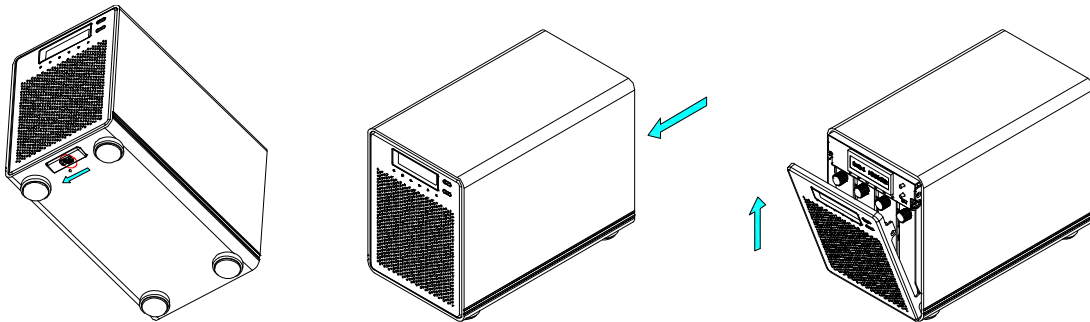

2. 按照下圖的方式安裝硬碟，硬碟的 SATA 傳輸端應朝向遠離前方面板的方向。請按照下圖的方式使用六個螺絲，從旁邊來固定您的硬碟。

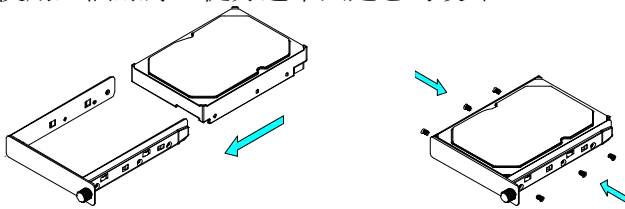

3. 將硬碟固定架裝回裝置中，請輕輕地將固定架放入，並鎖緊螺絲。
4. 重覆以上硬碟固定架的安裝順序，以安裝您所需要的其他硬碟。
5. 將前方面板裝回去，開啟電源，連接裝置到您的電腦，並設定 RAID 模式。接著創建一個新的磁區並格式化硬碟。

注意

您不能在不重新格式化硬碟的情形下，將新的硬碟加入到現有的磁碟陣列當中。若要新增硬碟的話，您必須先安裝硬碟，之後改變 RAID 模式或者重新格式化硬碟，接著再新增一個新的磁區，並再次格式化該磁區。

重要

當初次啟動本裝置，或者改變 RAID 模式時，任何在硬碟中的資料將會被消除。請確定您在安裝硬碟或改變 RAID 模式之前，已經備份您所有的資料！

2.2 更換硬碟

當一個硬碟損毀時，重建顯示燈號將顯示為黃色，而相對應的硬碟 LED 指示燈將顯示為紅色。若是只有一個硬碟損毀，且使用模式為 RAID 1、RAID 3、RAID 5 或 RAID 10 時，您的資料仍然可以存取。然而，我們強烈建議您馬上更換損毀的硬碟，以保證您資料的安全。

若多於一個硬碟在同時間損毀，或者 RAID 模式設定在 RAID 0 或磁碟延展模式時，您的資料將會損毀且無法存取，直到您更換新的硬碟為止。

1. 確認硬碟指示燈，當對應的指示燈為紅色時，表示該硬碟損毀，請更換新的硬碟。當在更換硬碟時，您並不須要關閉系統電源。
2. 更換硬碟數秒後，對應的指示燈將顯示為綠色。
3. 若您使用 RAID 1、RAID 3、RAID 5 或 RAID 10 模式，則硬碟陣列將會自動重建。當資料正在重建時，重建燈號將會顯示為閃爍黃燈。重建陣列將會花上幾個小時，這端看您的磁碟空間而定。
4. 若您使用 RAID 0 或磁碟延展模式，請清除舊的分割、並設定新的分割，之後重新格式化硬碟即可。

注意

我們建議在資料重建的時候不要關閉系統電源，但若資料重建中斷的話，它會在下一次電源開啟時繼續重建。

2.3 連線到電腦

當您使用本外接裝置的時候，請注意以下事項：

- 請不要將本裝置放入水中，或者曝露在潮濕的環境下
- 請不要擋住外接盒的散熱孔。
- 您只能同時使用一個連接埠連接至您的電腦。
- 當一個以上的連接埠連線到電腦時，eSATA 將會有最高的連接優先權。若您要使用其他的連接埠來連線到電腦時，請先將其他的傳輸線拔下，再連接想使用的傳輸線。
- 在連接裝置之前，安裝硬碟到外接盒內並設定好 RAID 模式
- 為了安全的移除裝置，而不造成任何的資料遺失，請使用正確的步驟來退出裝置。（例如：在拔掉傳輸線之前，先在電腦上移除裝置）
- 為了使電腦可以存取容量為 2TB 以上的硬碟磁區，您必須使用有支援大容量硬碟的作業系統（例如 Windows Vista/7 或 Mac OS 10.4 以上，否則請關閉支援 2TB 以上硬碟的設定選項。

3 LCD 顯示

您可以藉由裝置上的 LCD 螢幕，看到目前的系統狀態、硬碟詳細資訊，並且改變設定。

若要選擇選單或者改變設定，請按 [Select] 按鈕。要進入選單跟確認設定，請按 [OK] 按鈕。要知道更多詳細內容，請按照螢幕上的設定精靈，或者按照以下的說明來操作。

3.1 主選單

按下 [Select] 按鈕以在不同的選單之間切換，之後按下 [OK] 以進入選單。

1. 主畫面會顯示產品名稱跟目前的 RAID 模式
2. 系統資訊選單會顯示關於設定跟硬體的詳細資料
3. 硬碟資訊選單會顯示目前的硬碟詳細狀態
4. 設定選單可以使您改變裝置的設定

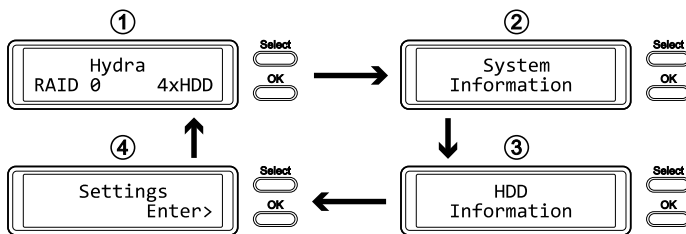

3.2 系統資訊

按下 [Select] 按鈕，直到系統資訊選單被選擇之後，按下 [OK] 以顯示關於設定跟硬體的詳細資料。螢幕會自動循環顯示各項資訊，每項資訊的顯示時間約為 8 秒，顯示完畢之後會回到主畫面。要快速切換顯示資訊的話請按 [Select] 按鈕。

1. 系統資訊的主畫面
2. 顯示產品序號，序號是一組結合 1394 ID、晶片 Hi ID 以及 Lo ID 的字串。
3. 顯示目前的韌體版本
4. I/O 狀態顯示目前連接到電腦的介面
5. 顯示目前的風扇速度以及溫度
6. 顯示目前的 >2TB 支援狀態以及警示功能
7. 顯示 RAID 是如何設定的 (LCM = LCD 螢幕, AP = 電腦程式) 以及硬碟總容量

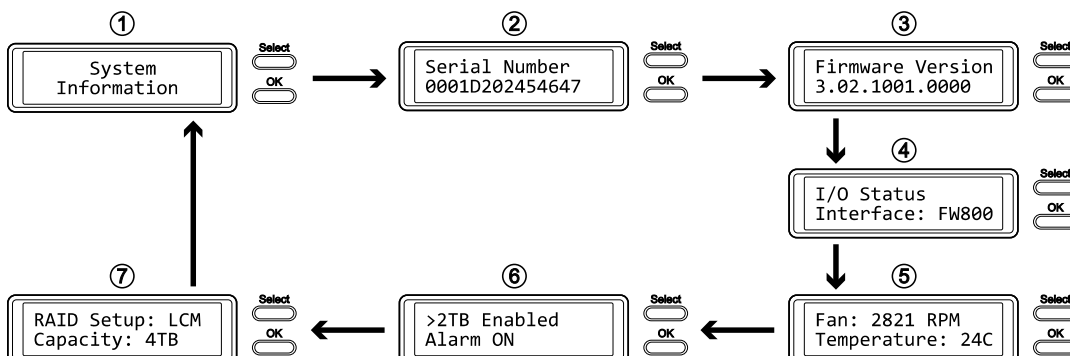

3.3 硬碟資訊

按下 [Select] 按鈕，直到硬碟資訊選單被選擇之後，按下 [OK] 以顯示關於目前的硬碟詳細狀態。螢幕會自動循環顯示各項資訊，每項資訊的顯示時間約為 8 秒，顯示完畢之後會回到主畫面。要快速切換顯示資訊的話請按[Select] 按鈕。

1. 硬碟資訊的主畫面
2. 顯示第一顆硬碟的型號以及序號
3. 顯示第一顆硬碟的總容量以及目前溫度
4. 第二顆到第四顆硬碟的資訊將也會按照上面的順序來顯示

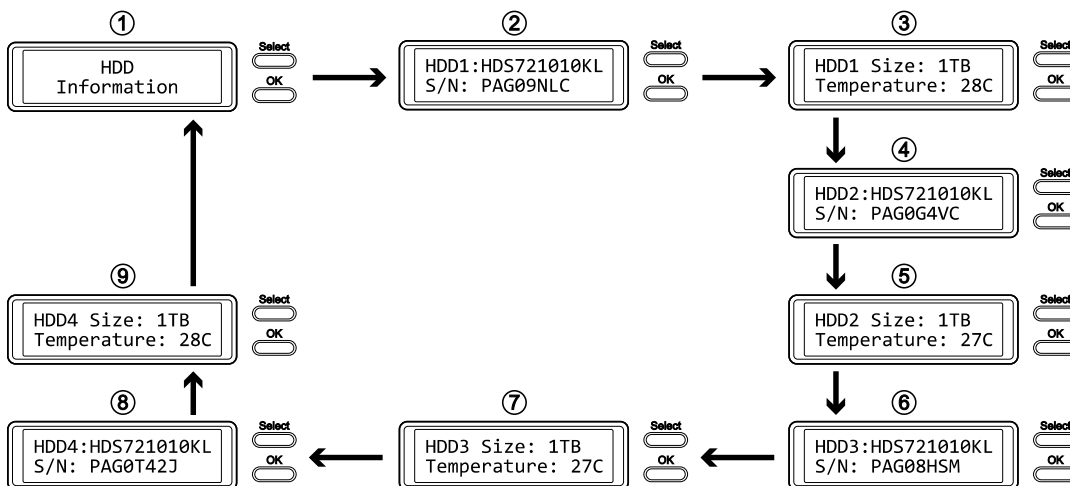

3.4 設定

按下 [Select] 按鈕，直到設定選單被選擇之後，按下 [OK] 以改變裝置的設定。接著您可以按 [Select] 以循環顯示各項設定選單，再按 [OK] 以改變設定。

1. 設定開啟或關閉大於 2TB 的硬碟支援
2. 設定 RAID
3. 開啟或關閉一般的警示聲音
4. 開啟或關閉溫度偵測的警示聲音
5. 設定風扇速度
6. 螢幕背光時間設定
7. 離開設定選單，回到主選單

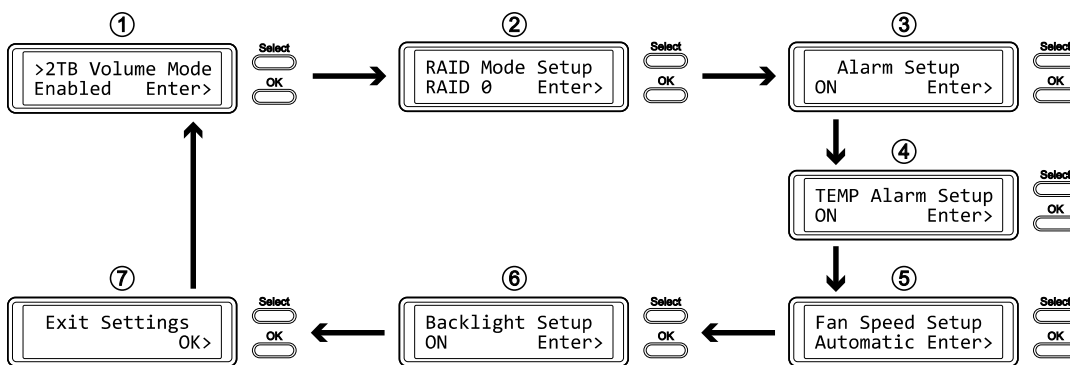

3.4.1 >2TB 支援模式

為了使電腦可以存取容量為 2TB 以上的硬碟磁區，您必須使用有支援大容量硬碟的作業系統（例如 Windows Vista/7 或 Mac OS 10.4 以上），否則請關閉 >2TB 的選項

- [Enabled] 支援 2TB 以上的硬碟。如果硬碟容量超過 2TB 的話，較舊的作業系統將無法存取該磁碟。
- [Disabled] 只支援 2TB 以下的硬碟。如果硬碟容量超過 2TB 的話，多餘的可用空間將會不顯示且無法存取。然而這可以使得較舊的作業系統也能存取硬碟。

按 [OK] 進入設定選單，按 [Select] 以在各個選項之間切換。

- 若您沒有要更改任何設定，而要離開選單時，請按 [Select] 直到出現離開選單畫面的選項，之後按下 [OK]。
- 若要改變設定，請按 [Select] 以選擇您想要的設定，之後按 [OK] 選擇之，再按一次 [OK] 以確認設定。

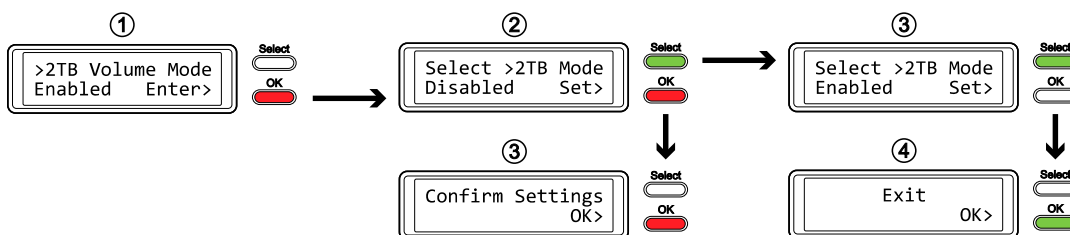

3.4.2 RAID 模式設定

若要改變 RAID 模式的話，請先確認您的 RAID 切換開關是處於解鎖的狀態。

- [SPAN] 磁碟延展模式
- [RAID 0] 磁碟分段模式
- [RAID 1/10] 磁碟鏡像模式（兩個硬碟 → RAID 1, 四個硬碟 RAID 10）。
- [RAID 3] 磁碟分段並使用專屬同位元檢查硬碟。若要使用備用硬碟的話，請先安裝三個硬碟到裝置中，之後開啟裝置，設定為 RAID3，等到系統重新啟動之後，再安裝第四個硬碟。
- [RAID 5] 磁碟分段並使用分散式同位元檢查。若要使用備用硬碟的話，請先安裝三個硬碟到裝置中，之後開啟裝置，設定為 RAID5，等到系統重新啟動之後，再安裝第四個硬碟

按 [OK] 進入設定選單，按 [Select] 以在各個選項之間切換。

- 若您沒有要更改任何設定，而要離開選單時，請按 [Select] 直到出現離開選單畫面的選項，之後按下 [OK]。
- 若要改變設定，請按 [Select] 以選擇您想要的設定，之後按 [OK] 選擇之，再按一次 [OK] 以確認設定，最後再按一次 [OK] 以確認刪除所有資料。裝置會自動重新啟動，在重新啟動之後，系統會在向您確認新的 RAID 模式。

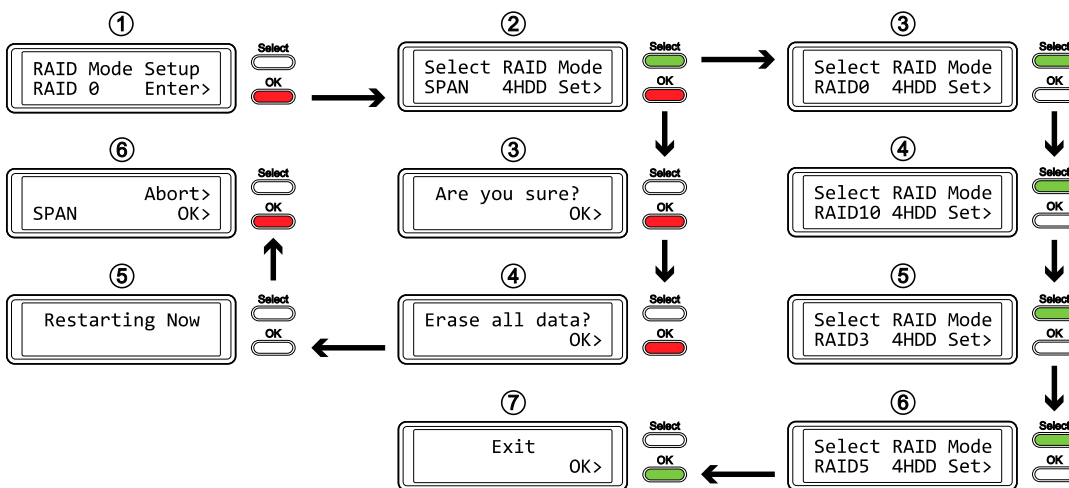

注意

改變 RAID 模式會對硬碟執行重新格式化，並清除所有的檔案，請務必在此之前備份所有的資料！

目前所安裝的硬碟數量將會顯示在目前 RAID 模式的右邊（例如：4HDD）這項資訊僅提供參考使用，而不能改變或選擇。因此，RAID 模式所使用的硬碟數量將會是上面所顯示的目前硬碟數量。

3.4.3 警示設定

當系統啟動的時候，會有一短聲的“嗶”聲，此外，在系統有錯誤的時候它也會響起。您可以在設定中選擇切換警示聲音的開啟或關閉。

- [ON] 開啟警示
- [OFF] 關閉警示

按 [OK] 進入設定選單，按 [Select] 以在各個選項之間切換。

- 若您沒有要更改任何設定，而要離開選單時，請按 [Select] 直到出現離開選單畫面的選項，之後按下 [OK]。
- 若要改變設定，請按 [Select] 以選擇您想要的設定，之後按 [OK] 選擇之，再按一次 [OK] 以確認設定。

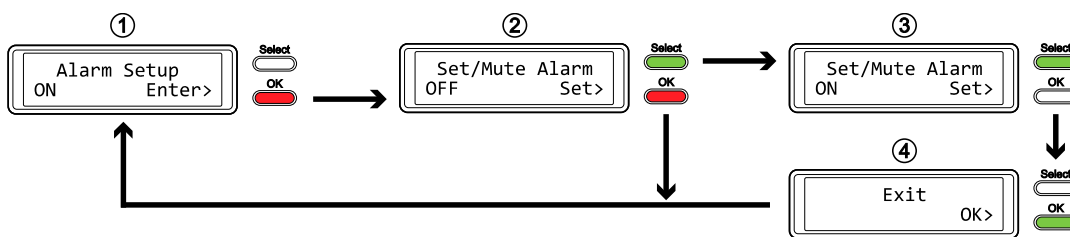

3.4.4 溫度偵測警示設定

當裝置內部的溫度到達警示標準（大於 61°C）時，警示聲會響起。您可以在設定中選擇切換警示聲音的開啟或關閉。

- [ON] 開啟高溫偵測警示
- [OFF] 關閉高溫偵測警示

按 [OK] 進入設定選單，按 [Select] 以在各個選項之間切換。

- 若您沒有要更改任何設定，而要離開選單時，請按 [Select] 直到出現離開選單畫面的選項，之後按下 [OK]。
- 若要改變設定，請按 [Select] 以選擇您想要的設定，之後按 [OK] 選擇之，再按一次 [OK] 以確認設定。

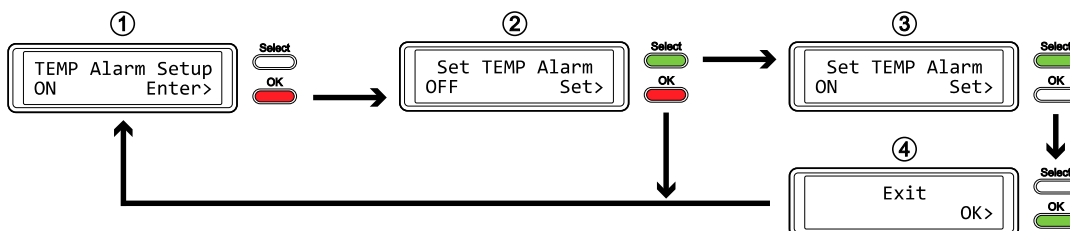

3.4.5 風扇速度設定

在本裝置中的智慧型風扇，會隨著裝置內部溫度而自動調整轉速。您可以手動設定風扇速度，或者關閉風扇。

- [Automatic] 隨著硬碟溫度而自動調整風扇速度（低於 45°C = 低速, 45-60°C = 五階段升速, 高於 61°C = 高速）
- [HighSpeed] 風扇設定為高速
- [LowSpeed] 風扇設定為低速
- [OFF] 關閉風扇。請在當裝置處在低溫且有恆溫控制的房間中使用時，才使用此設定。

按 [OK] 進入設定選單，按 [Select] 以在各個選項之間切換。

- 若您沒有要更改任何設定，而要離開選單時，請按 [Select] 直到出現離開選單畫面的選項，之後按下 [OK]。
- 若要改變設定，請按 [Select] 以選擇您想要的設定，之後按 [OK] 選擇之，再按一次 [OK] 以確認設定。

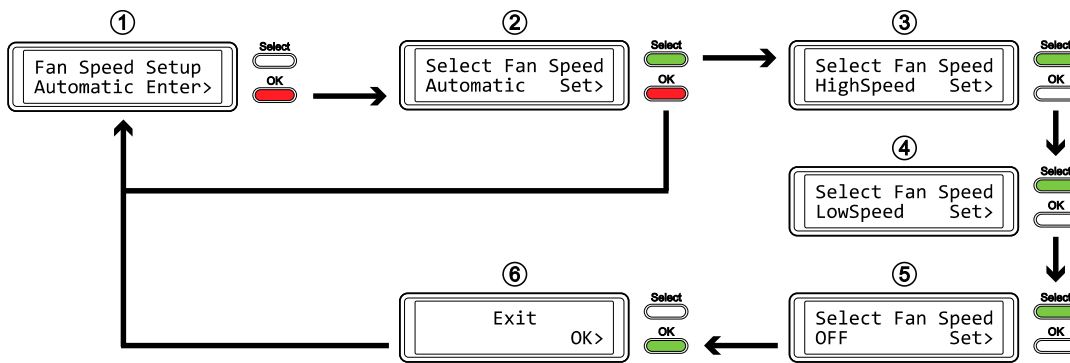

3.4.6 背光設定

LCD 螢幕的背光可以設定為開啟或關閉，或者設定為在螢幕閒置幾分鐘之後自動關閉。

- [ON] 總是開啟
- [OFF] 總是關閉
- [1min] 背光將在螢幕閒置一分鐘之後關閉
- [3min] 背光將在螢幕閒置三分鐘之後關閉
- [5min] 背光將在螢幕閒置五分鐘之後關閉

按[OK] 進入設定選單，按 [Select] 以在各個選項之間切換。

- 若您沒有要更改任何設定，而要離開選單時，請按 [Select] 直到出現離開選單畫面的選項，之後按下 [OK]。
- 若要改變設定，請按 [Select] 以選擇您想要的設定，之後按 [OK] 選擇之，再按一次 [OK] 以確認設定。

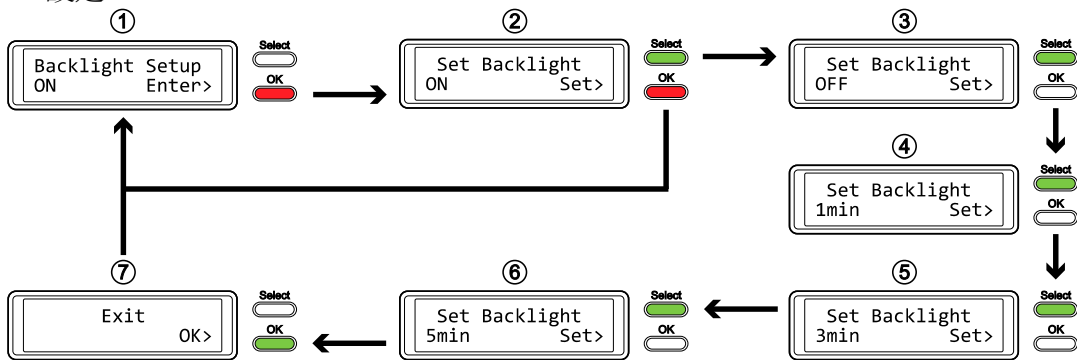

3.5 狀態資訊

除了顯示硬體資訊以及設定項目之外，LCD 螢幕也會顯示以下的狀態資訊，您可以參考以下的說明以得知這些狀態的詳細資訊。

- **[HDD Error / Remaining 3xHDD]**

當您使用 RAID 0 或磁碟延展模式，而有一個硬碟損毀時，系統將會顯示此訊息。您可以藉由硬碟指示燈以得知是哪個硬碟損毀

- **[RAID Warning / Degraded Array]**

當您使用 RAID 1、10、3 或 5 模式，而有一個硬碟損毀時，系統將會顯示此訊息。按下 [OK] 以暫時忽略警示訊息。您可以藉由硬碟指示燈以得知是哪個硬碟損毀

- **[XX Cable / Connected]**

顯示目前連接了哪種傳輸線

- **[Cable / Disconnected]**

當傳輸線拔掉的時候顯示此訊息

- **[Rebuilding... / Hrs left xhxxmin]**

當重建 RAID 陣列的時候會顯示此訊息，並顯示估計重建完成所需要的時間

- **[Alarm / High Temperature]**

顯示裝置目前處於高溫警示狀態（高於 61°C）

- **[Alarm / Fan Failure]**

顯示風扇故障，或者風扇在無預警的情況下降低轉速

- **[Detecting Disk / Starting...]**

當系統啟動時會顯示此訊息

- **[XX / Starting ...]**

當系統啟動時會顯示此訊息

- **[RAID Mode Locked]**

當您要改變 RAID 模式，但 RAID 模式已經被鎖定時，會顯示此訊息

4 附錄

4.1 安全資訊

4.1.1 6-pin FireWire 傳輸線

當您使用 6-pin 的 FireWire 傳輸線時，請確定您插入傳輸線的方向是正確的，否則將可能造成裝置的損壞!

4.1.2 放置環境

請不要在裝置的上面擺上其他東西，或者將裝置放在其他需遠離熱源的東西上。並請避免將裝置放置在以下環境中:

- 陽光直射的地方，或者其他熱源附近（溫度高於 35°C），或者濕度大於 90% 的地方
- 在會震動的環境，或者放置在斜面上
- 請勿將本裝置放在水中，或者曝露在高濕度的環境下

4.1.3 電源供給

請注意以下幾點，以避免造成機器故障或電擊、火災等危險:

- 請務必先將您的裝置接上電源供應器，再將插頭插上。
- 請不要在手潮濕的情況下去碰觸電源供應器，並且請勿嘗試改裝、修理電源供應器
- 若裝置產生煙霧、有異味，或者有不正常的聲音時，請馬上關閉裝置
- 只使用原廠提供，或者建議的線材，以避免發生任何的故障或危險

4.2 FAQ

Q: 當我格式化硬碟時，我該選擇怎樣的資料系統?

A: 這個問題會隨著你想怎樣使用您的裝置而定，然而一般來說，我們建議:

- Windows XP/Vista/7 → NTFS
- Mac OS X → HFS+ (Mac OS Extended)
- 其他 → FAT32 (單檔大小限制在 4GB 以下)

Q: 當我有幾個硬碟損毀時，我的資料才會遺失?

A: 若您使用 RAID 0 或者磁碟延展模式的話，任何一個硬碟損毀都會造成您的資料遺失。若您使用 RAID 1、3、5 或 10 的話，當兩個硬碟同時損毀時，才會造成資料遺失而無法復原。

Q: 當我的電腦進入待機模式時，硬碟會降低轉速嗎?

A: 不會，為了使您可以隨時存取您的資料，只要是在裝置開啟時，硬碟都將會持續處於運作狀態。

Q: 為什麼某一個硬碟的 LED 指示燈會變為紅色?

A: 若有一個硬碟的 LED 指示燈轉為紅色，且硬碟重建指示燈轉為黃色時，表示該硬碟已經損毀。若您只安裝四個以下的硬碟，且硬碟重建指示燈並沒有亮起時，紅色的 LED 指示燈僅表示該硬碟槽是空的。

© Copyright 2010 by AKiTiO - All Rights Reserved

本使用手冊裡的內容經過仔細確認與校對，以確保內容正確無誤，如果使用手冊的內容有其它的錯誤，AKiTiO 不負任何責任，並且保有對本產品的規格及外觀改變而不另行通知的權力。使用手冊中的圖示僅供參考，以實際產品為準。如果說明書中的描述與實際產品不同或者有所差異，AKiTiO 不負任何責任。本公司依著作權法，享有及保留一切著作之專屬權力，未經本公司同意，不得就本使用手冊改編、翻印或仿製之行為。